

Molteni & C

WISH — RODOLFO DORDONI 2009

1—
4



Attraverso linee essenziali e raffinate, Wish esprime la sapiente lavorazione del legno e l'attenzione dedicata ai dettagli, per creare un classico senza tempo. Morbidi cuscini per la testata in tessuto o pelle si combinano con i legni: rovere grigio, rovere grafite, rovere nero. La versione eucalipto è realizzata in massello e tranciato tinto.

**SCHEDA
TECNICA**

REGISTERED
DESIGN

IX.2018

moltenigroup.com

Dimensioni espresse in centimetri e pollici. L'azienda si riserva il diritto di apportare modifiche ai modelli senza preavviso. Le informazioni qui riportate sono basate sugli ultimi dati pubblicati a listino.

FINITURE

RIVESTIMENTI CUSCINI TESTATA

tessuto - pelle, completamente sfoderabili.

FINITURE ESSENZA STRUTTURA

rovere grigio - rovere grafite - rovere nero - eucalipto

INFORMAZIONI TECNICHE

TESTATA E PIEDI

In legno massello di Rovere (Quercus) con feltrini per appoggio a terra. Per la versione Eucalipto si tratta di Noce canaletto (Juglans nigra) tinto.

GUIDE PERIMETRALI

Pannello in listellare di betulla (Betula alba) rivestito con tranciato di legno Rovere o Noce canaletto tinto Eucalipto.

FASCE SUPERIORI

Pannello multistrati di betulla rivestito con tranciato di legno Rovere o Noce canaletto tinto Eucalipto.

CUSCINI TESTATA

Inserto in poliuretano espanso e piuma sterilizzata. Fodera in cotone 100%. Appoggio su pannelli in particelle di legno rivestiti con tranciato di legno Rovere.

RIVESTIMENTI ESTERNI SFODERABILI

(Vedi etichetta allegata, specifica del rivestimento).

SUPPORTO REGOLABILE RETE

In metallo tropicalizzato con cappuccio in PVC morbido.

SUPPORTO CENTRALE PER RETE (OPTIONAL)

In metallo verniciato.

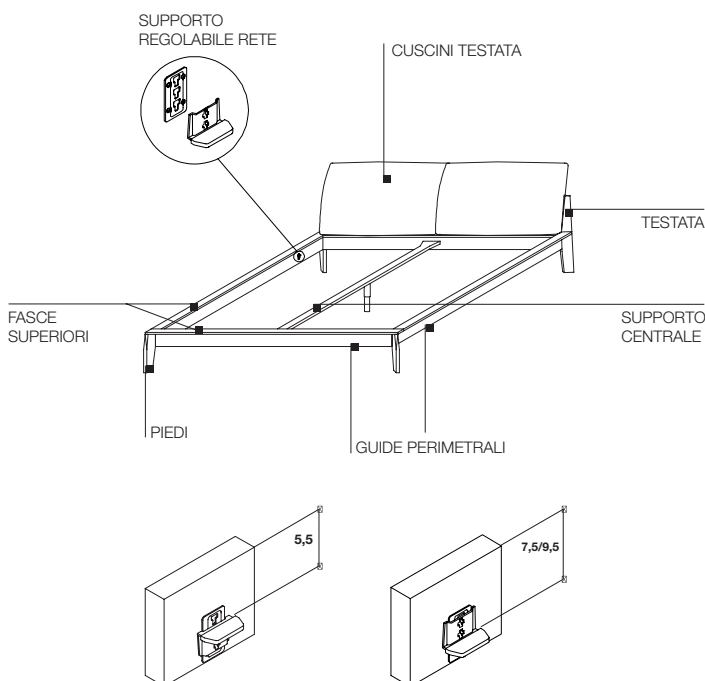

SCHEDA TECNICA

REGISTERED
DESIGN

IX.2018

DIMENSIONI

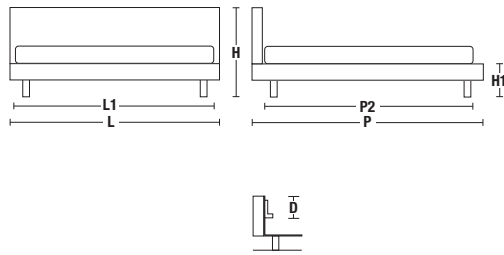

DIMENSIONI ESTERNE			DIMENSIONI INTERNE		
L	P	H	L1	P2	D
Larghezza	Profondità	Altezza	Larghezza	Profondità	Altezza utile inserimento rete
180 70 7/8"	231 91" di serie	86 33 7/8"	160 63"	200 78 3/4" di serie	5,5 2 1/8"
190 74 3/4"	241 94 7/8" a richiesta	H1 Altezza piano letto	170 66 7/8"	210 82 3/4" a richiesta	7,5 3"
200 78 3/4"	234 92 1/8" per QS/KS	32 12 5/8"	QS155 61"	205 80 3/4" per QS/KS	9,5 3 3/4"
KS214 84 1/4"			KS195 76 3/4"		

A richiesta è possibile disporre della profondità 210 cm (82 3/4") (misura interna) su WLE16 - WLE17 - WLE18.

Molteni & C

letti per inserimento reti matrimoniali

WLE16

struttura rovere grigio
struttura rovere nero
struttura eucalipto
struttura rovere grafite

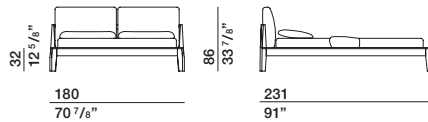

WLE17

struttura rovere grigio
struttura rovere nero
struttura eucalipto
struttura rovere grafite

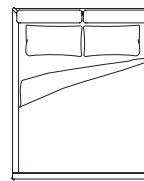
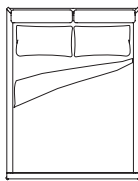
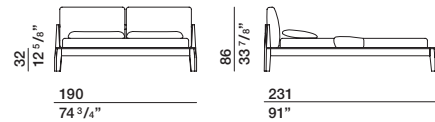

WLE18

struttura rovere grigio
struttura rovere nero
struttura eucalipto
struttura rovere grafite

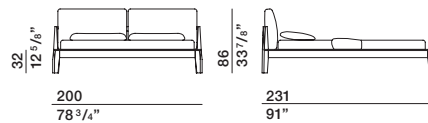

WLEQS

struttura rovere grigio
struttura rovere nero
struttura eucalipto
struttura rovere grafite

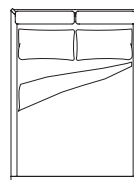
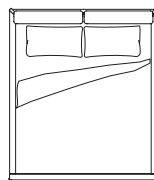
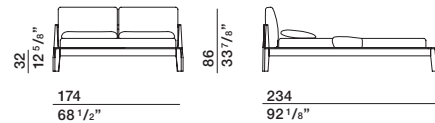

WLEKS

struttura rovere grigio
struttura rovere nero
struttura eucalipto
struttura rovere grafite

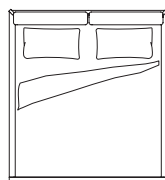
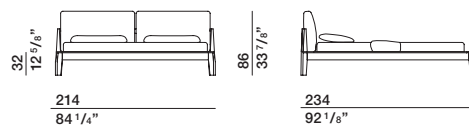

SCHEDA TECNICA

REGISTERED
DESIGN

IX.2018

DIMENSIONI

letti con supporto centrale per inserimento doppie reti singole

WLE16T

struttura
 rovere grigio
 rovere nero
 rovere grafite

struttura
 eucalipto

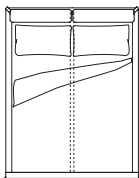
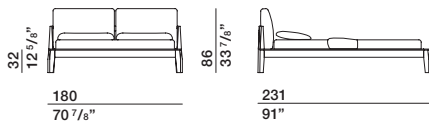

WLE17T

struttura
 rovere grigio
 rovere nero
 rovere grafite

struttura
 eucalipto

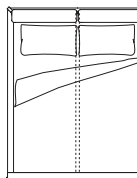
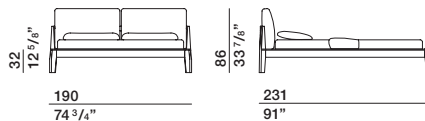

WLE18T

struttura
 rovere grigio
 rovere nero
 rovere grafite

struttura
 eucalipto

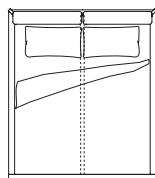
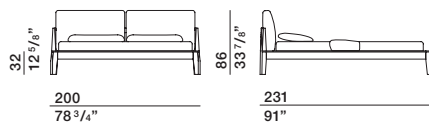

WLEQST

struttura
 rovere grigio
 rovere nero
 rovere grafite

struttura
 eucalipto

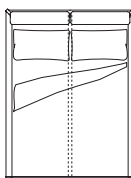
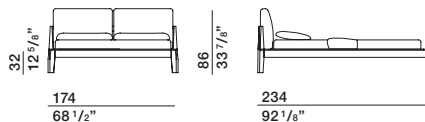

WLEKST

struttura
 rovere grigio
 rovere nero
 rovere grafite

struttura
 eucalipto

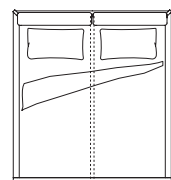
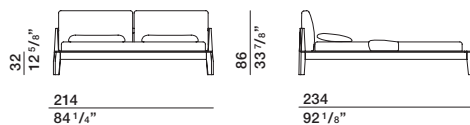

Molteni & C

4

4

SCHEDA
 TECNICA

REGISTERED
 DESIGN

IX.2018

Molteni & C

**FINITURE
GAMMA
MOLTENI&C
IX.2018**

	LACCATO OPACO	LACCATO LUCIDO	VETRO COLORATO	VETRO ACIDATO COLORATO	CARTAPAGLIA LACCATO solo Gliss Master	VETRO STOPSOL VETRO STOPOL TRASPARENTE
BIANCO CALCE	•	•	•	•	•	
PERLA	•	•	•	•	•	
SILICE	•	•	•	•	•	
SABBIA	•	•	•	•	•	
TORTORA	•	•	•	•	•	
PLATINO	•	•	•	•	•	
DUNA	•	•	•	•	•	
ARGILLA	•	•	•	•	•	
DOLOMITE	•	•	•	•	•	
RAME	•	•	•	•	•	
RUGGINE	•	•	•	•	•	
RUBINO	•	•	•	•	•	
CARAMELLO	•	•	•	•	•	
MOKA	•	•	•	•	•	
SENAPE	•	•	•	•	•	
CARTA DA ZUCCHERO	•	•	•	•	•	
PELTRO	•	•	•	•	•	
ANTRACITE	•	•	•	•	•	
NERO	•	•	•	•	•	
STOPSOL						•
ROSSO LESSLESS solo laccato opaco	•					

Le finiture fornite sono solo indicative e si riferiscono all'intera produzione. Si raccomanda di consultare il campionario "Gamma Colori" completo di tutte le finiture, anche quelle qui non riportate. Molteni&C si riserva di apportare modifiche senza obbligo di preavviso.

ESSENZE

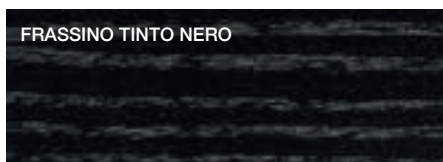
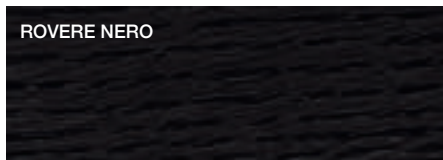
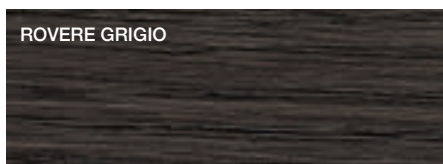

MARMI

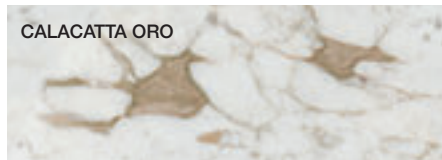
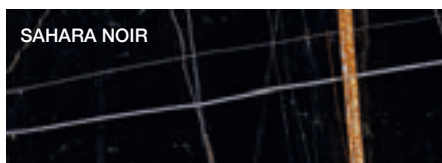
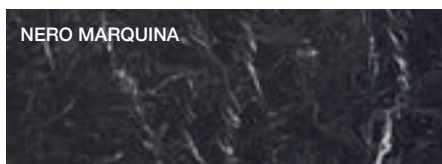
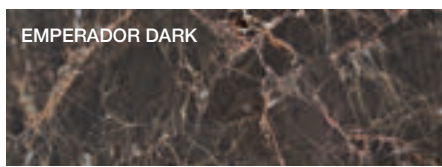
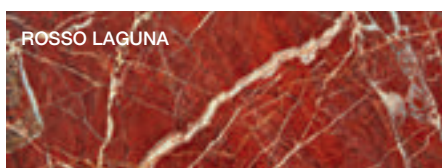
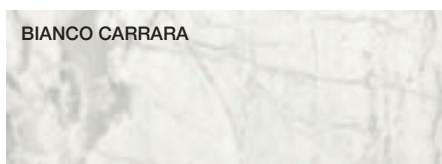

PARTI METALLICHE

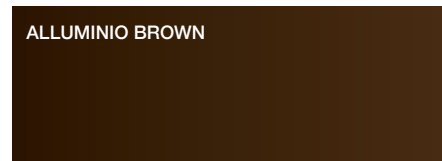
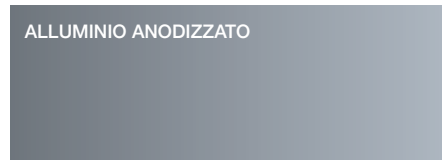
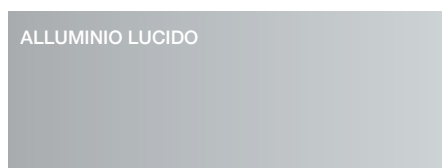
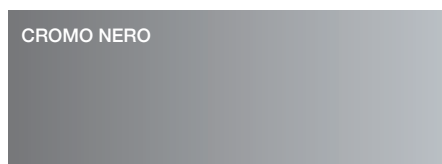

NOBILITATO FACCIATA
GLISS MASTER

CARTAPAGLIA BIANCO

CARTAPAGLIA ANTRACITE

CARTAPAGLIA SILICE

GRAFFIATO SILICE

GRAFFIATO BRONZO

TORTORA SILK

SILICE SILK

BIANCO CALCE SILK

NOBILITATO STRUTTURA
GLISS MASTER

SHANTUNG BIANCO

SHANTUNG GRIGIO

NOBILITATO STRUTTURA
GLISS MASTER, MASTER DRESSING,
GLISS WALK-IN

CEMBRO ARGENTO

LARIX MORO

NOBILITATO STRUTTURA
GLISS MASTER, MASTER DRESSING

WHITE

ECO SKIN

AVORIO

CANAPA

VISONE

TESTA DI MORO

GRIGIO

FINE GRAIN

FINE GRAIN